

Probing Dark Matter with Gravitational-Wave Interferometers in Space

Yong Tang (汤勇)

University of Chinese Academy of Sciences (中国科学院大学)

第三届地下和空间粒子物理与宇宙物理前沿问题研讨会

西昌, 2020.5.7-11

w/ Li, and Wu, arXiv:2112.14041; Yu, Yao, Wu, arXiv:2307.09197;

Zhang, arXiv:2403.13882; Yao, arXiv:2404.10494; Yu, Cao, Wu, arXiv:2404.04333

Contents

1

Motivation

2

Dark Matter – WIMP and Wave DM

3

Gravitational-Wave Interferometers in Space

4

Sensitivity and Time-Delay Interferometry

5

Summary

Motivation

- Standard model is not complete
- Dark Matter and Dark Energy
- Neutrino mass
- Matter-Antimatter asymmetry
- Theoretical Problems
 - Strong CP problem
 - Hierarchy problem
 - Fermion mass hierarchy
 - Unification of forces
 -

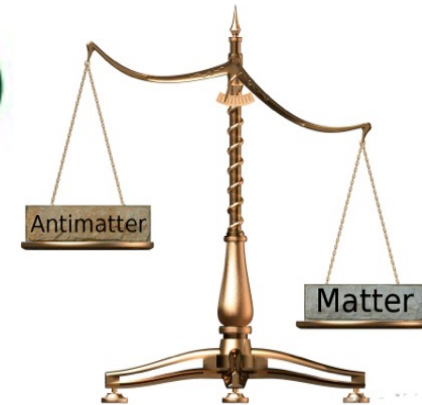
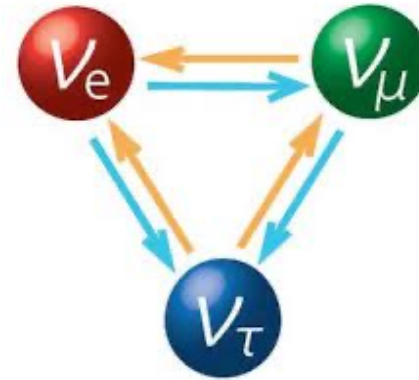
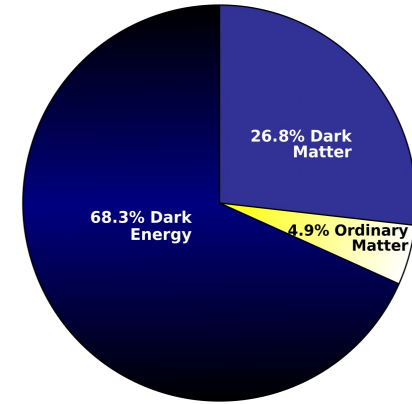
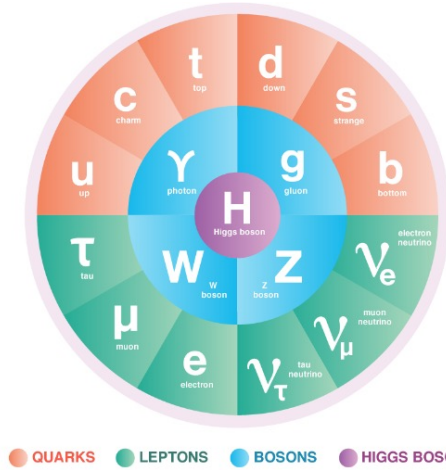

Evidence for Dark Matter

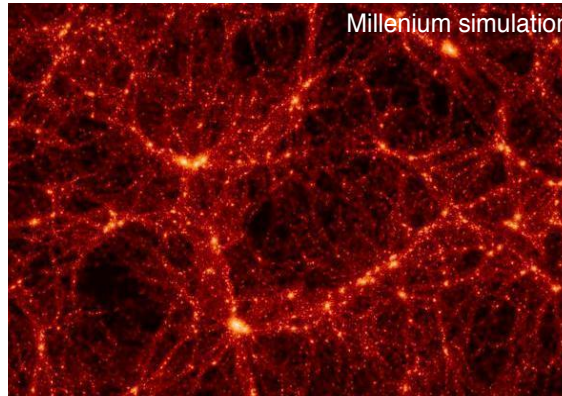
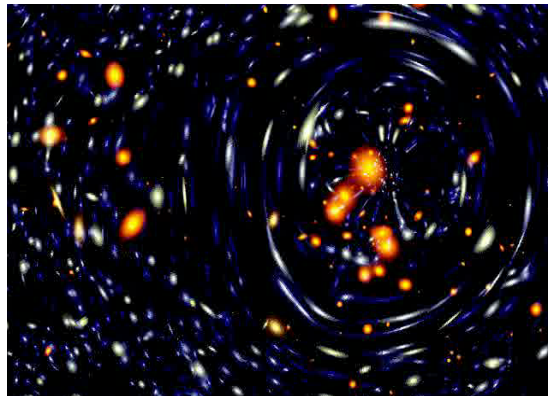
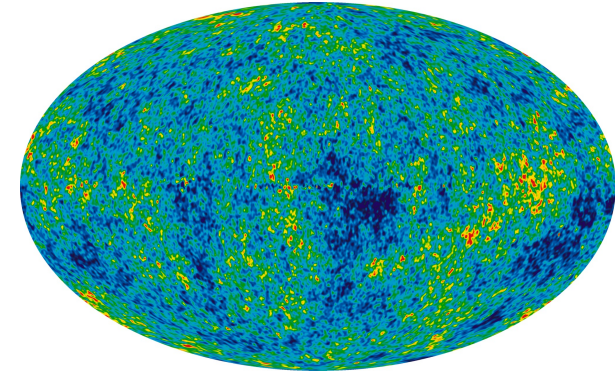
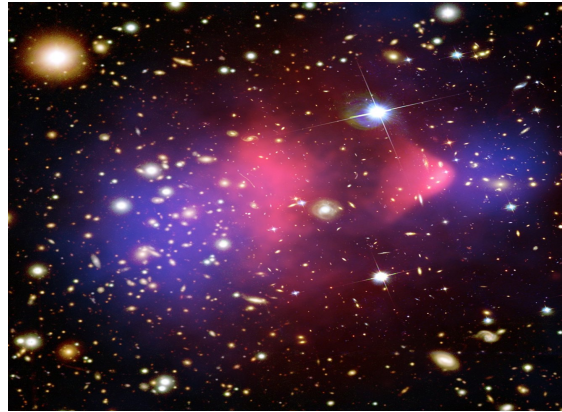
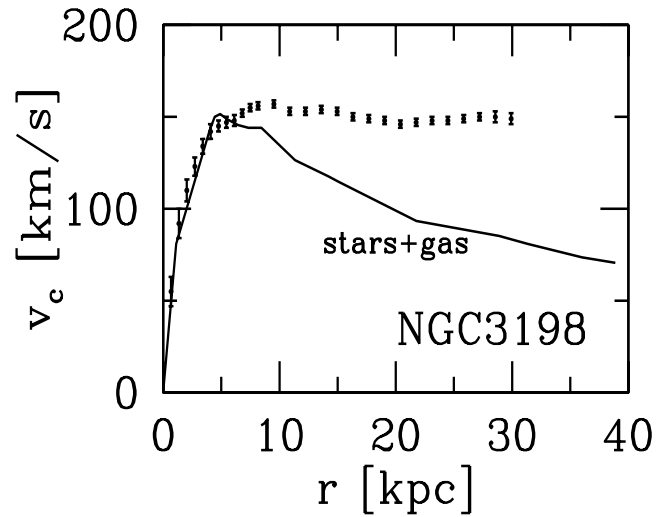

- Rotation curve
- Gravitational lensing
- Bullet cluster
- Large-scale structure
- Anisotropy of CMB

Dark Matter Candidates

- Primordial black holes
- Super heavy particles
- Asymmetric DM
- Hidden sector DM
-
- Weakly-interacting (WIMP)
- Strongly-interacting (SIMP)
- Axion (ALP), Ultralight DM
- Sterile neutrino

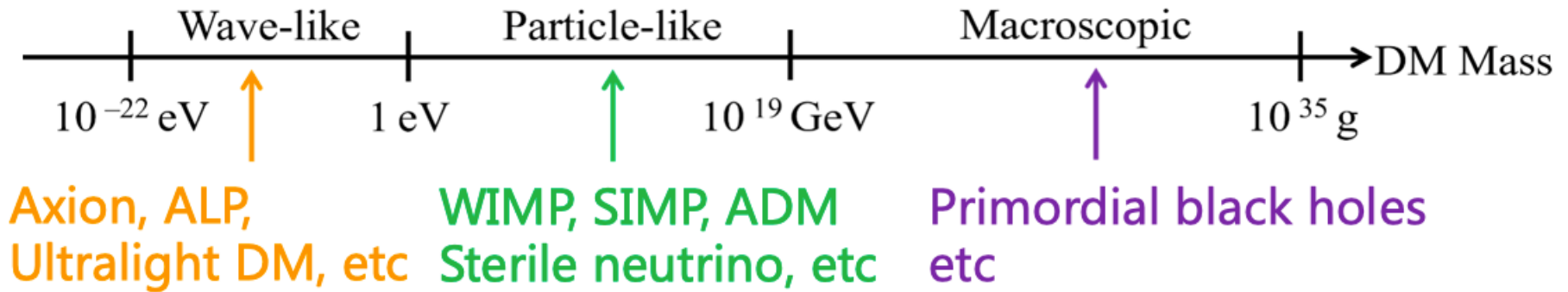

Dark Matter Candidates

- Primordial black holes
- Super heavy particles
- Asymmetric DM
- Hidden sector DM
-
- **Weakly-interacting (WIMP)**
- Strongly-interacting (SIMP)
- **Axion (ALP), Ultralight DM**
- Sterile neutrino

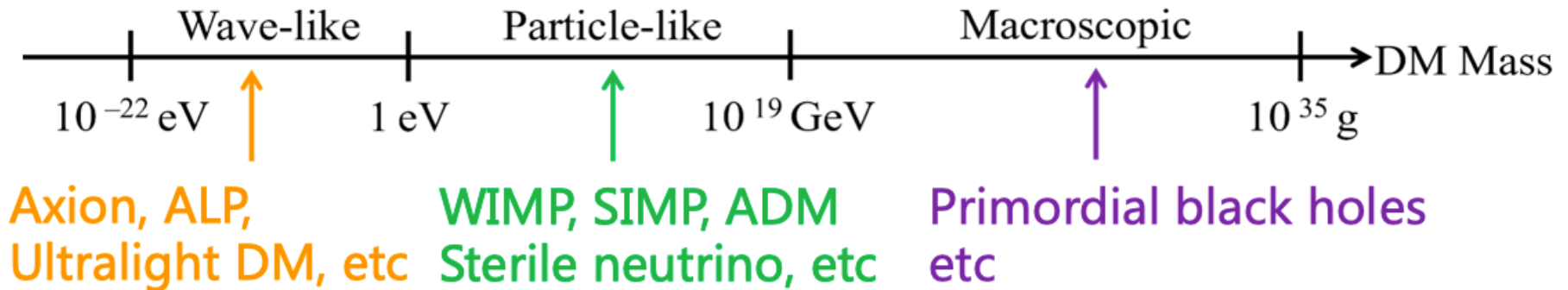

WIMP

- Mass ~ 100 GeV
- Coupling constant ~ 0.5
- Relic abundance $\Omega \sim 0.3$
- Thermal history
 1. Equilibrium $XX \leftrightarrow ff$
 2. Equilibrium $XX \rightarrow ff$
 3. Freeze out
- Cold dark matter
- The&Exp attractive

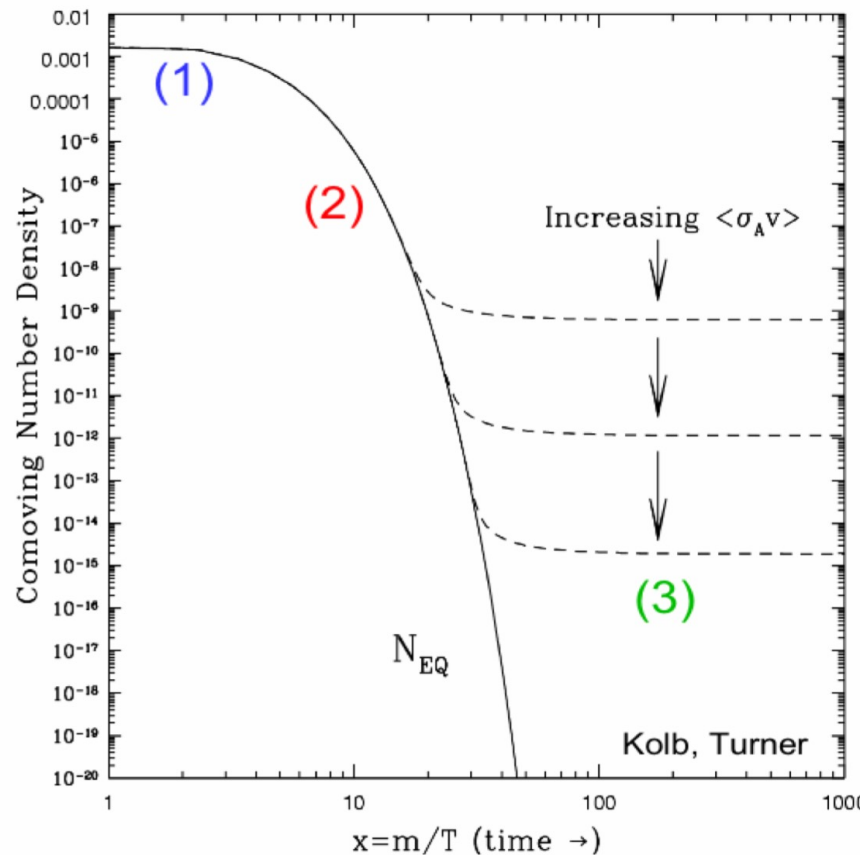

WIMP

- Theories: supersymmetry, extra dimensions,
- Direct, indirect and collider searches
- Impressive progresses

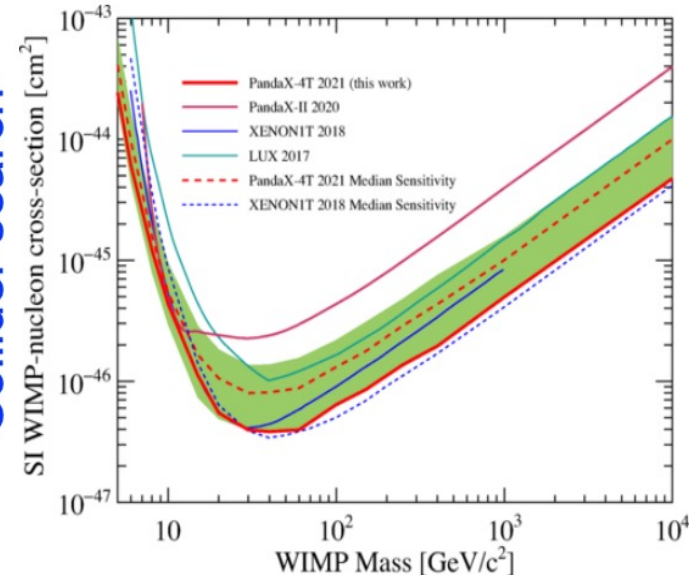
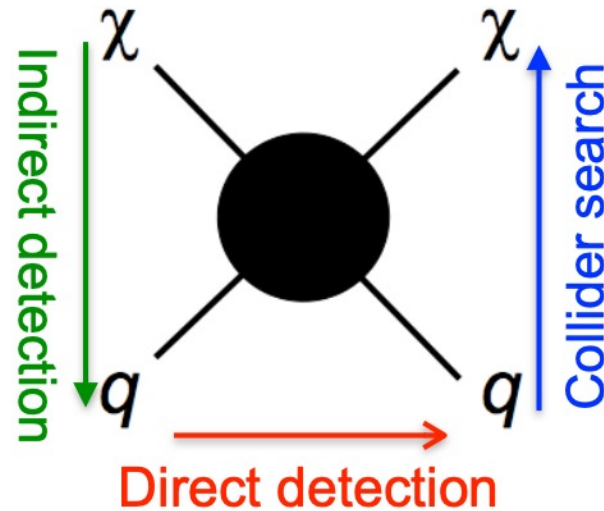
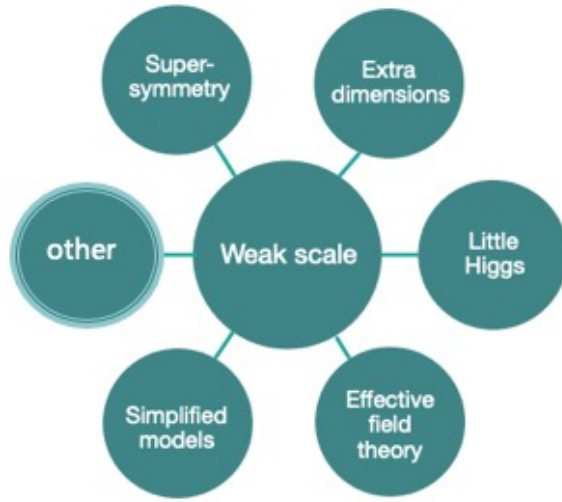

Ultralight Dark Matter

- Mass < 1 eV, QCD axion, axion-like-particles, bosonic
- Number density is very large, behaves as classical wave

$$\Phi(x) = \sum_{\mathbf{v}} \frac{\sqrt{2\rho/N}}{m} e^{i(\omega t - \mathbf{k} \cdot \mathbf{x} + \theta_{\mathbf{v}})},$$

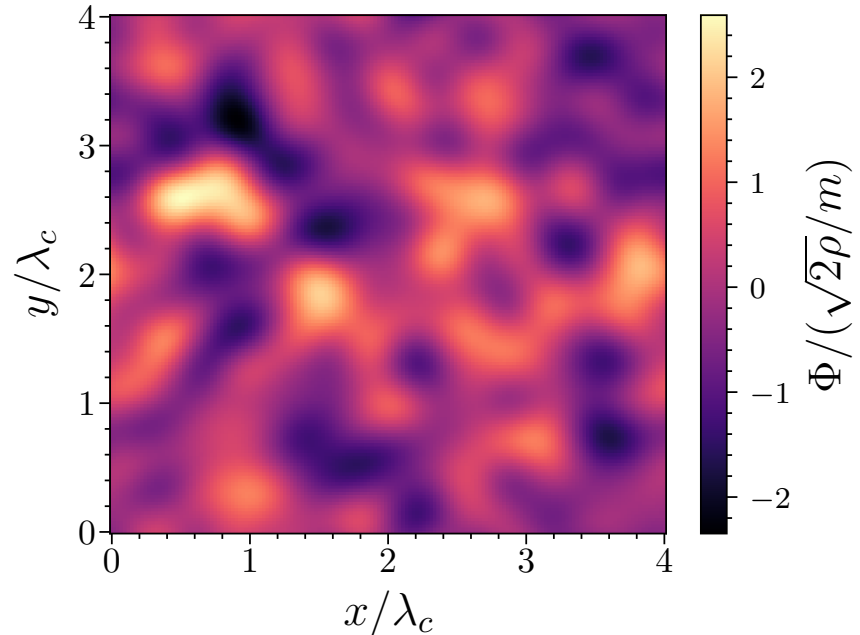
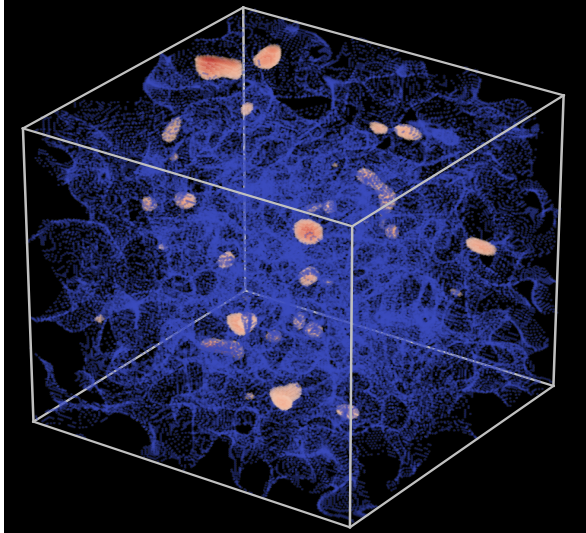

Ultralight Dark Matter

➤ Scalar field ϕ

$$\mathcal{L} = \frac{1}{2} \partial^\mu \phi \partial_\mu \phi - \frac{1}{2} m_\phi^2 \phi^2 - C \frac{\phi}{M_P} \mathcal{O}_{\text{SM}}, \quad \phi(t, \vec{x}) = \phi_{\vec{k}} e^{i(\omega t - \vec{k} \cdot \vec{x} + \theta_0)},$$

➤ Interaction depending on the underlying theory, e.g.

$$C \frac{\phi}{M_P} m_\psi \bar{\psi} \psi \Rightarrow m_\psi \rightarrow \left(1 + C \frac{\phi}{M_P}\right) m_\psi, \quad S = - \int m(\phi) \sqrt{-\eta_{\mu\nu} dx^\mu dx^\nu}.$$

$$\delta x^i(t, \vec{x}) = \mathcal{M}_s \hat{k}^i e^{im_\phi(t - v \hat{k} \cdot \vec{x})}, \quad \mathcal{M}_s \propto \phi_{\vec{k}} |\vec{k}| / m_\phi^2$$

➤ Vector field A_μ

$$\mathcal{L} = -\frac{1}{4} F^{\mu\nu} F_{\mu\nu} + \frac{1}{2} m_A^2 A^\nu A_\nu - \epsilon_{DE} J_D^\nu A_\nu, \quad \vec{A}(t, \vec{x}) = |\vec{A}| \hat{e}_A e^{i(\omega t - \vec{k} \cdot \vec{x})},$$

$$\delta x^i(t, \vec{x}) = \mathcal{M}_v \hat{e}_A^i e^{im_A(t - v \hat{k} \cdot \vec{x})}, \quad \mathcal{M}_v \propto \epsilon_{DE} q_{D,j} |\vec{A}| / m_A M_j$$

➤ DM property

$$\phi_{\vec{k}} = \frac{\sqrt{2\rho_{\text{DM}}}}{m_\phi}, \quad |\vec{A}| = \frac{\sqrt{2\rho_{\text{DM}}}}{m_A}, \quad v \sim 10^{-3}, \quad \vec{k} \approx m_\phi \vec{v} \text{ and } \omega \approx m_\phi$$

Physical Effects

➤ Atomic physics

- Arvanitaki, Huang & Tilburg (2014), Graham, Kaplan, Mardon, Rajendran & Terrano (2015), Safronova, Budker, DeMille, Kimball, Derevianko & Clark (2018),
- Stadnik (2022), ……

➤ Astrophysical physics

- Pierce, Riles & Zhao (2018), Morisaki & Suyama (2019), Guo, Riles, Yang & Zhao 2019 , Grote & Stadnik (2019),
- An, Huang, Liu & Xue (2021), Chen, Shu, Xue, Yuan & Zhao (2019), Xia, Xu & Zhou (2020), Sun, Yang & Zhang (2021), Wu, Chen, & Huang (2023),
- Liu, Lou & Ren (2021), Luu, Liu, Ren, Broadhurst, Yang, Wang & Xie (2023), ……

➤ Underground searches

- Dark Matter Experiments, PandaX, XENONnT, …

Space-based GW Interferometers

- LISA, Taiji, TianQin, DECIGO, BBO, LISAMax, ASTROD-GW, μ Ares

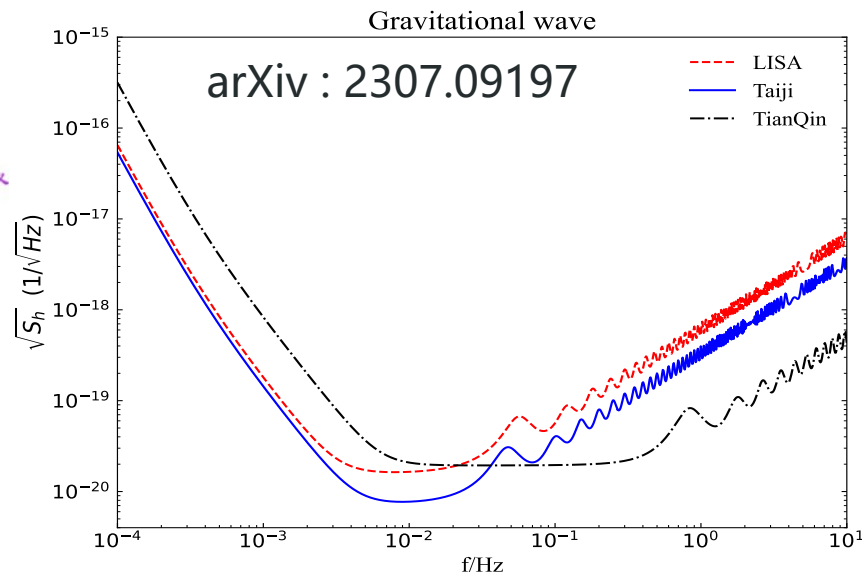
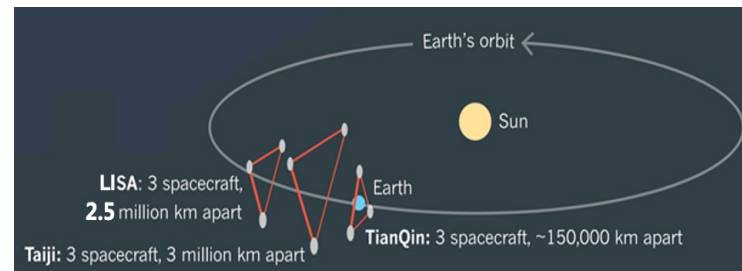
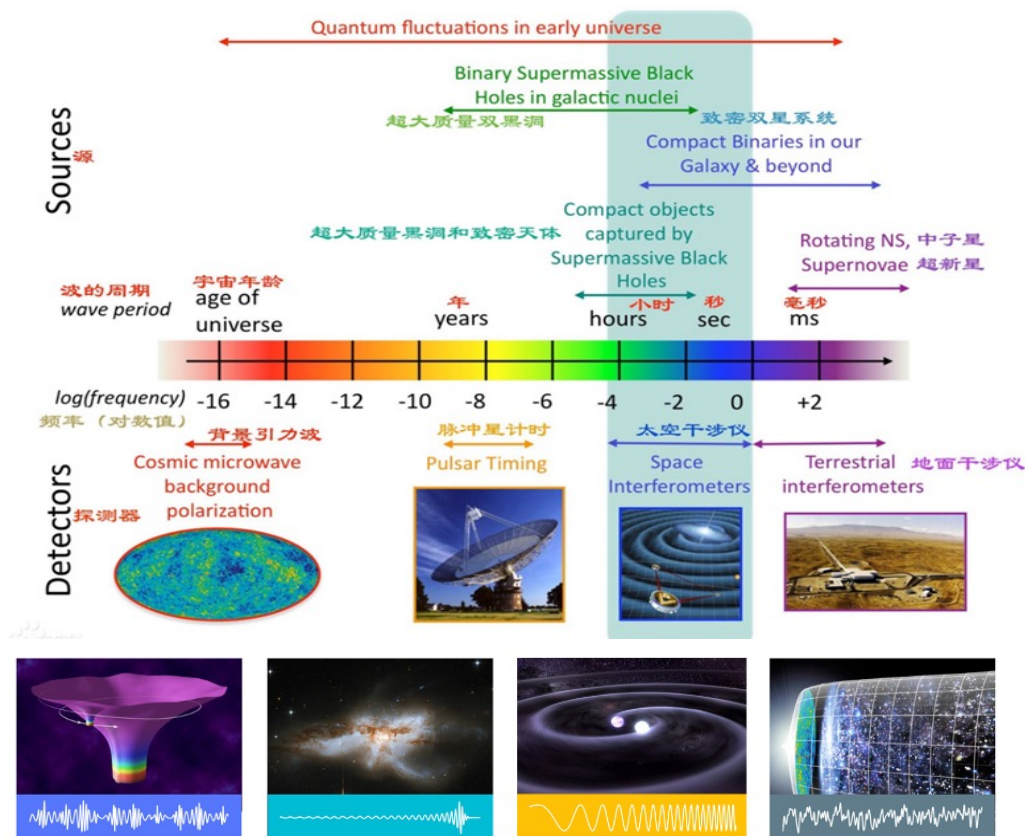

Signal Response

- Gravitational wave can change the structure of spacetime, and the physical distance between objects

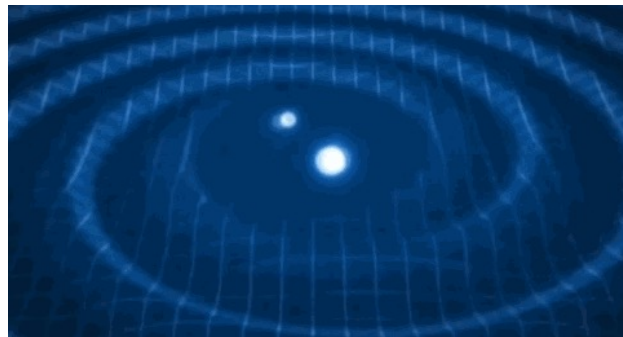
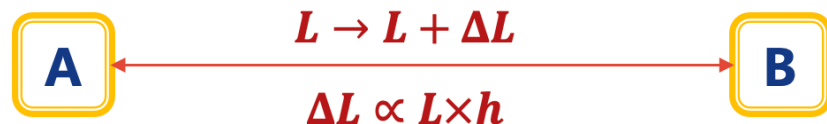

- One can measure the phase by laser

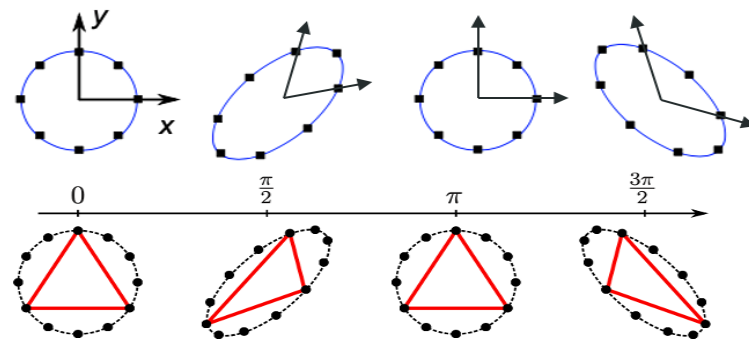
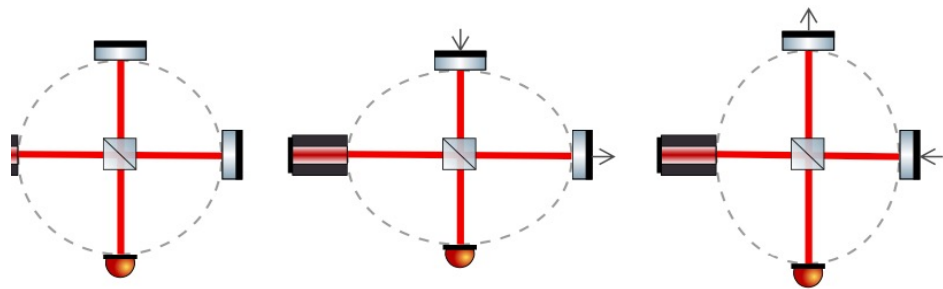

- Response $\frac{\delta v(t)}{v_0} \equiv y_{BA} = -\frac{1}{2} \frac{n_i n_j}{1 + \vec{k} \cdot \vec{n}} \left[h_{ij} \left(t - \frac{\vec{k} \cdot \vec{x}_B}{c} \right) - h_{ij} \left(t - \frac{\vec{k} \cdot \vec{x}_{A+L}}{c} \right) \right]$

DM spikes

➤ WIMP DM particles accretion around BH → DM spike

➤ NFW profile → spiky density profile Gondolo & Silk (1999)

$$\rho(r) \propto r^{-\gamma}, 0 \leq \gamma \leq 2 \quad \Rightarrow \quad \rho_{\text{spike}}(r) = \rho_{\text{sp}} \left(\frac{r_{\text{sp}}}{r} \right)^\alpha, \quad \alpha = \frac{9 - 2\gamma}{4 - \gamma}$$

➤ Dynamical friction → Gravitational wave

Extreme-mass-ratio Inspiral (EMRI)

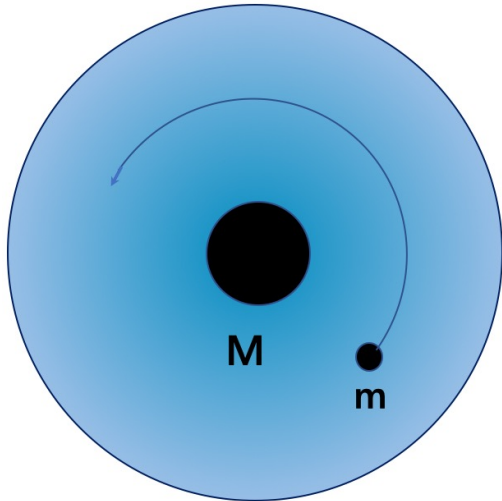

$$m \frac{d^2 \mathbf{x}}{dt^2} = \mathbf{F}_G + \mathbf{F}_{\text{DF}}$$

$$h_{ij} \sim \frac{G}{d} \frac{d^2 Q_{ij}}{dt^2},$$

$$Q_{ij} \sim m \left(x_i x_j - \frac{1}{3} x^2 \delta_{ij} \right)$$

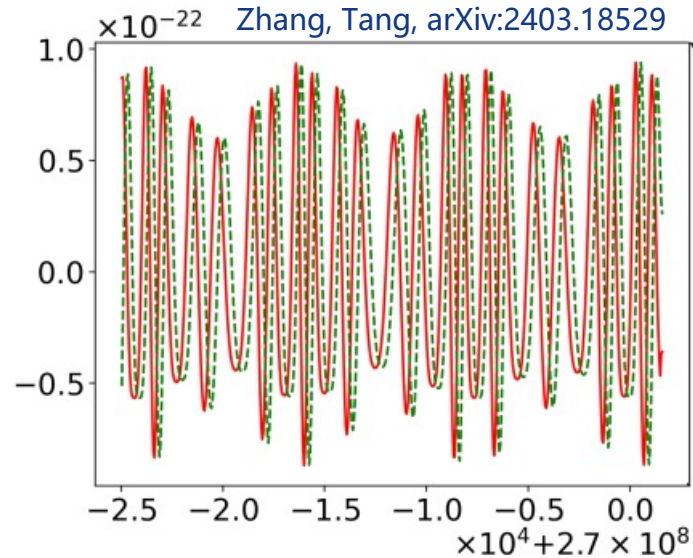

DM spikes

- WIMP DM particles accretion around BH → DM spike
- NFW profile → spiky density profile Gondolo & Silk (1999)

$$\rho(r) \propto r^{-\gamma}, 0 \leq \gamma \leq 2 \quad \Rightarrow \quad \rho_{\text{spike}}(r) = \rho_{\text{sp}} \left(\frac{r_{\text{sp}}}{r} \right)^\alpha, \quad \alpha = \frac{9 - 2\gamma}{4 - \gamma}$$

- Dynamical friction → Gravitational wave

Extreme-mass-ratio Inspiral (EMRI)

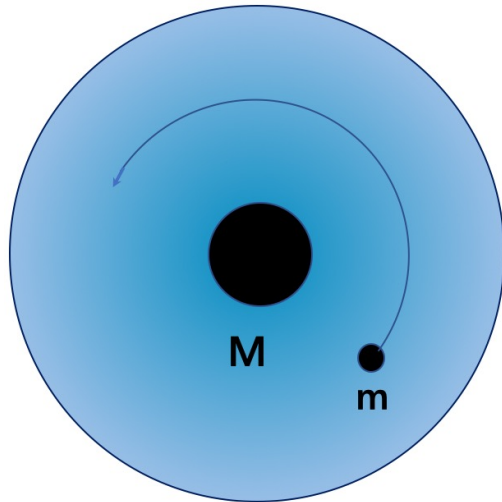

$$m \frac{d^2 \mathbf{x}}{dt^2} = \mathbf{F}_G + \mathbf{F}_{\text{DF}}$$

$$h_{ij} \sim \frac{G}{d} \frac{d^2 Q_{ij}}{dt^2},$$

$$Q_{ij} \sim m \left(x_i x_j - \frac{1}{3} x^2 \delta_{ij} \right)$$

Li, Tanq, Wu, arXiv:2112.14041

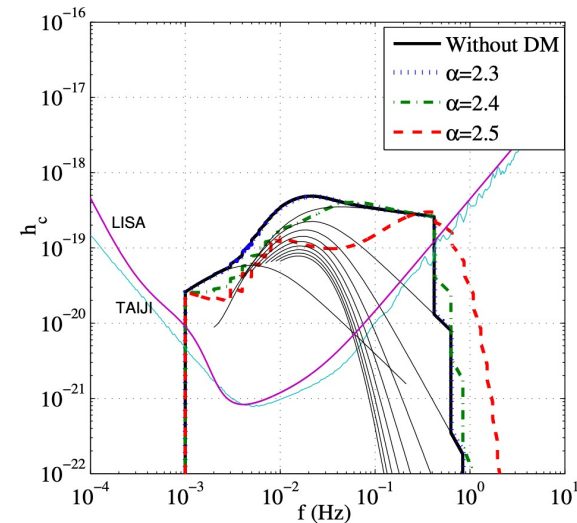

Density Distribution

➤ Relativistic treatment (Will et al)

$$\rho(r, \alpha = 1) = \frac{\kappa}{(r/GM)^\omega} \left(1 - \frac{4GM}{r}\right)^\eta.$$

Halo parameters	Index	Fitting parameters
(M_{halo}, r_s)	(γ)	(κ, η, ω)
$(10^{12} M_\odot, 20 \text{ kpc})$	-	$(5.33 \times 10^{20} \text{ GeV/cm}^3, 1.99, 2.07)$
$(4.5 \times 10^8 M_\odot, 1.85 \text{ kpc})$	-	$(6.15 \times 10^{24} \text{ GeV/cm}^3, 2.03, 2.11)$
$(7.3 \times 10^8 M_\odot, 1.85 \text{ kpc})$	7/4	$(5.83 \times 10^{26} \text{ GeV/cm}^3, 2.04, 2.16)$

Zhang, Tang, arXiv:2403.18529

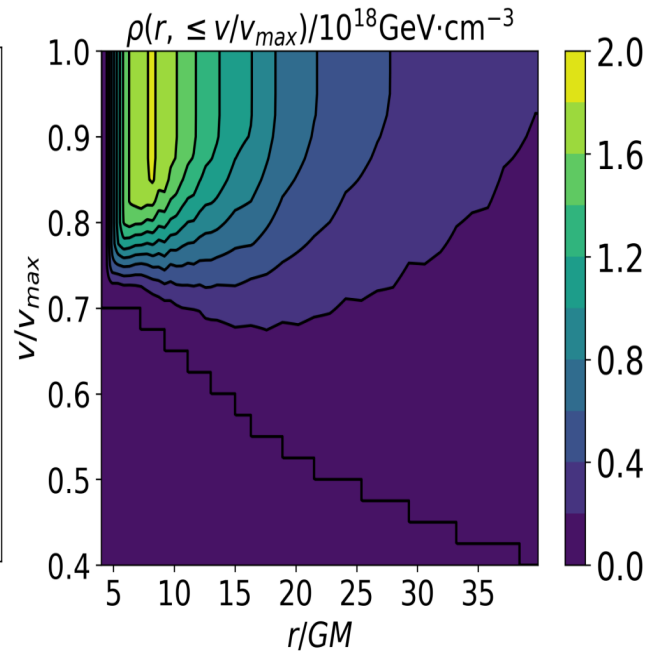
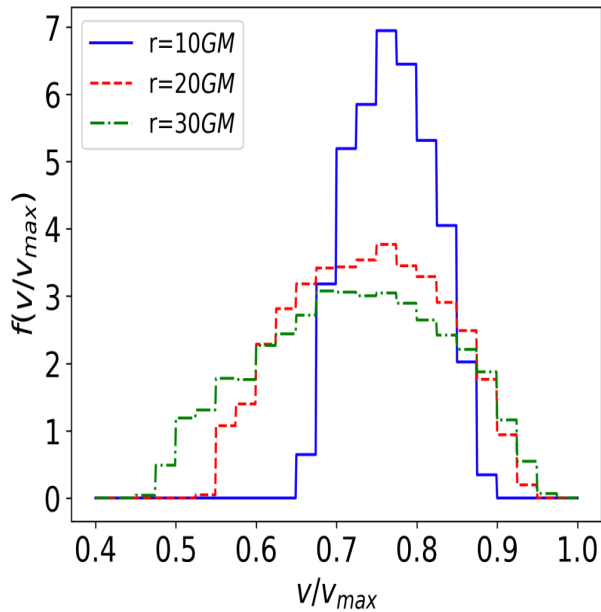
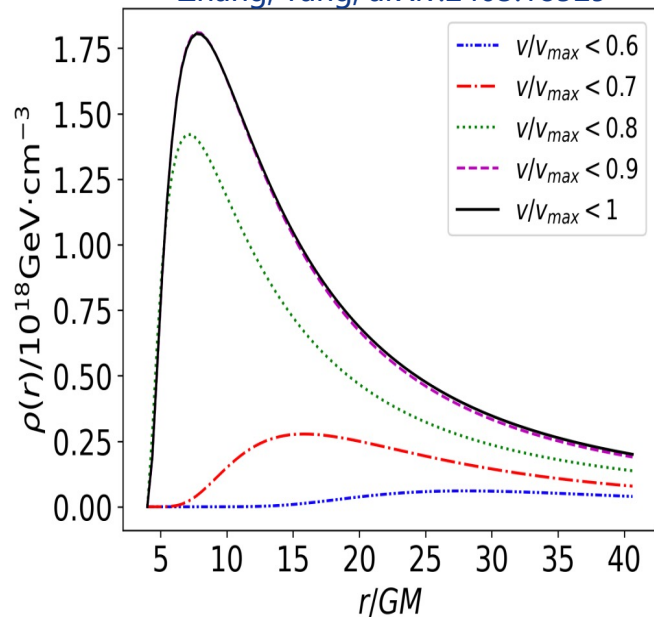

Velocity Distribution

- Fitted with Gaussian distribution

$$f_r(v) = \frac{1}{\sqrt{2\pi}\sigma(r)} \exp\left(-\frac{(v - \bar{v}(r))^2}{2\sigma^2(r)}\right),$$

Fitting of distribution

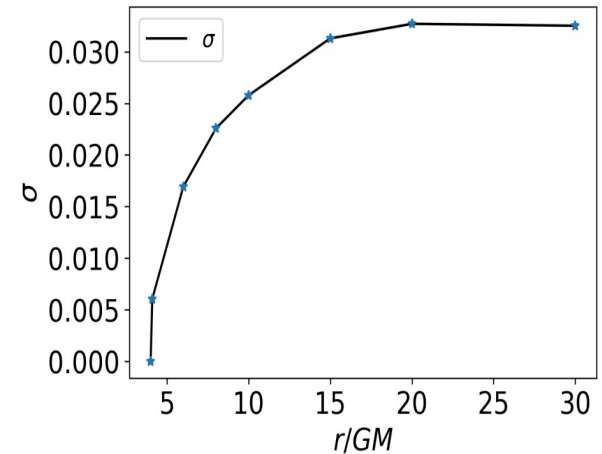
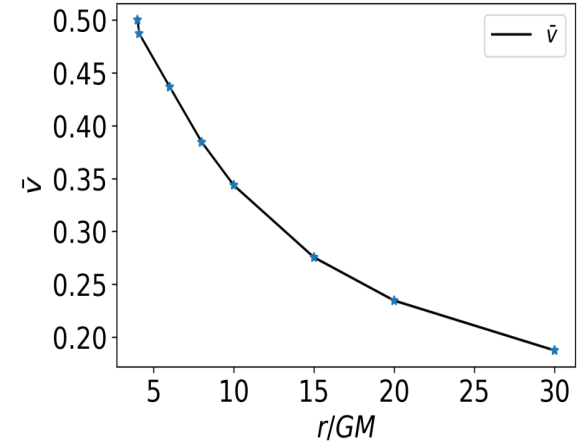
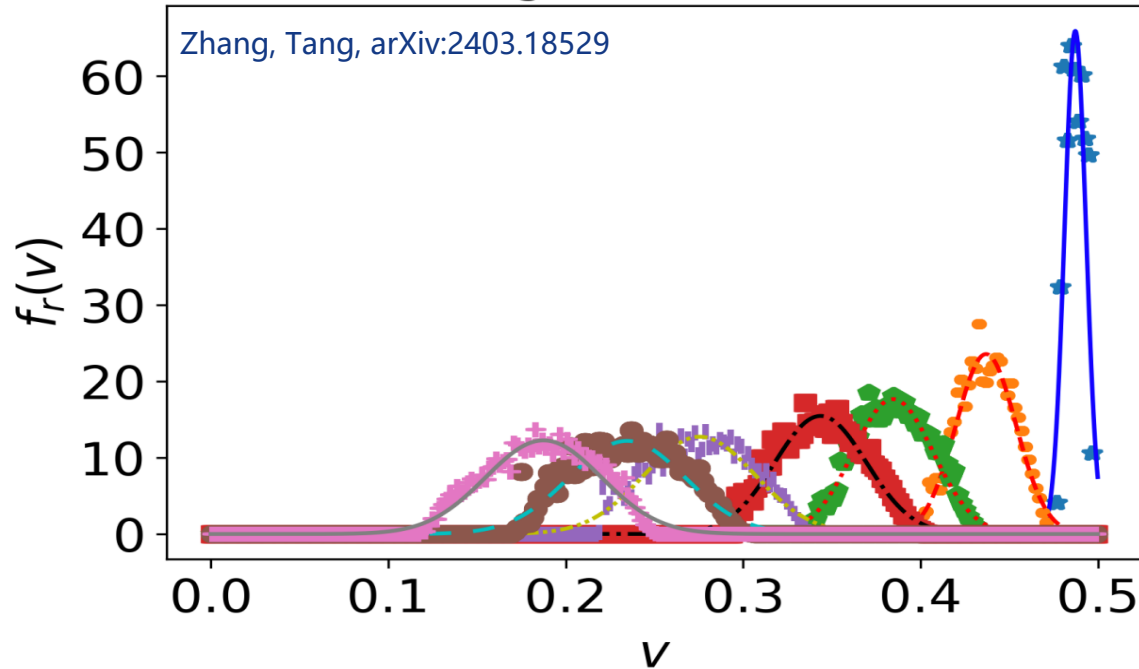

Effects on EMRI

➤ Phase shift of the waveform of GW

Zhang, Tang, arXiv:2403.18529

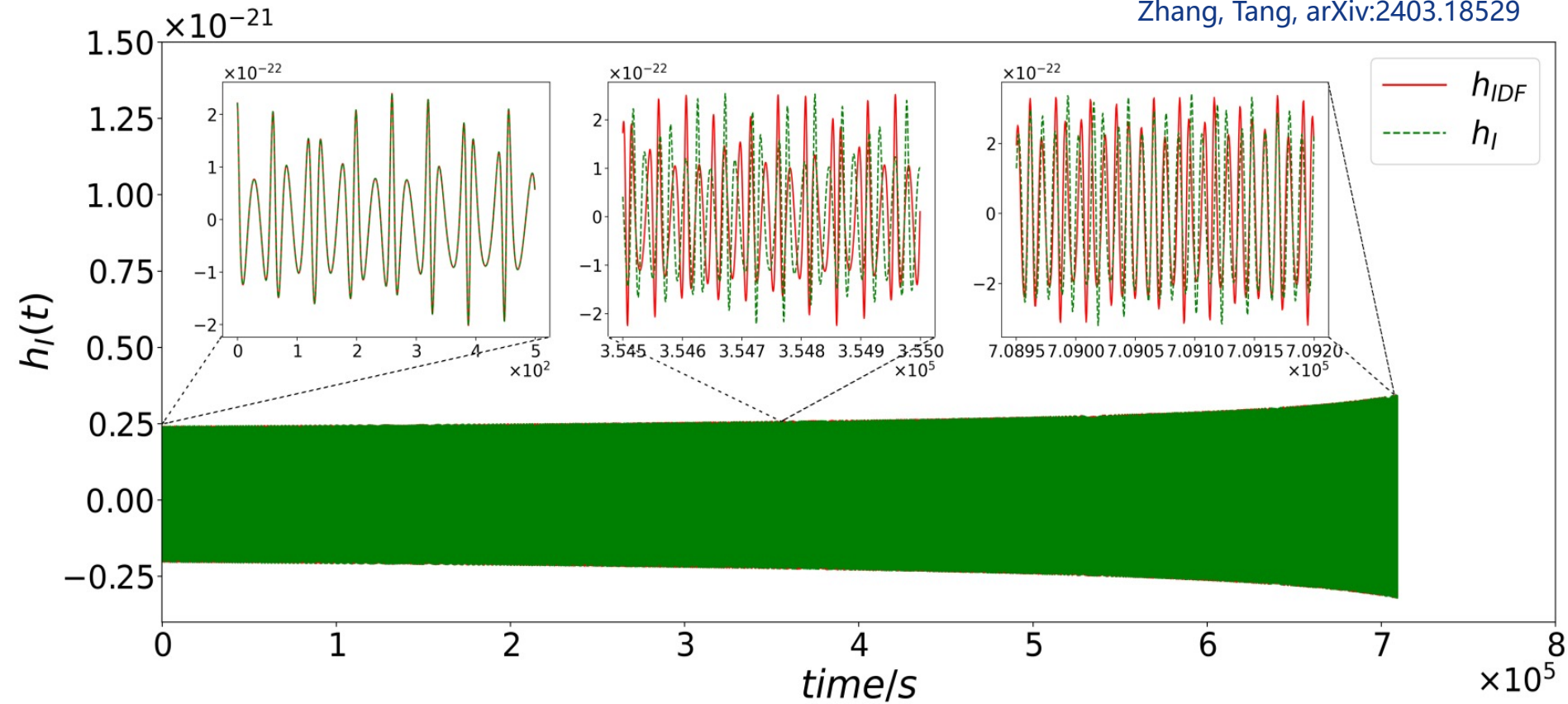

Ultralight DM - Signal Response

- DM couples to SM particles, inducing oscillations of test mass, effectively changing the length
- One-way Doppler shift



$$\delta t_{rs} = -\hat{n}_{rs} \cdot [\delta \vec{x}(t, \vec{x}_r) - \delta \vec{x}(t - L, \vec{x}_s)],$$

$$\frac{\delta \nu_{rs}}{\nu_0} = \frac{\nu_{rs} - \nu_0}{\nu_0} = -\frac{d \delta t_{rs}}{dt}.$$

- Fractional frequency change

$$y_{rs}(t) \equiv \frac{\delta \nu_{rs}}{\nu_0} = \mu_{rs} [h(t, \vec{x}_r) - h(t - L, \vec{x}_s)], \quad h(t, \vec{x}) \propto e^{im(t - v\hat{k} \cdot \vec{x})}$$

$$\mu_{rs} = \begin{cases} \hat{k} \cdot \hat{n}_{rs} & \text{for scalar field,} \\ \hat{e}_A \cdot \hat{n}_{rs} & \text{for vector field,} \\ \frac{\hat{n}_{rs}^i \hat{n}_{rs}^j e_{ij}(\hat{k}, \psi)}{2(1 + \hat{n}_{rs} \cdot \hat{k})} & \text{for gravitational wave,} \end{cases}$$

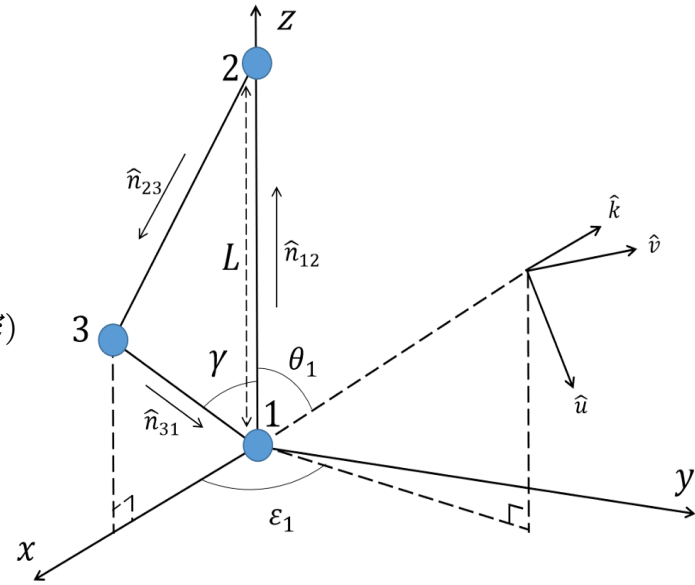

Yu, Yao, Tang, Wu, arXiv: 2307.09197

Time-Delay Interferometry

- The arm lengths are not equal
- Laser frequency noises dominate

$$\begin{aligned}
 X(t) &\equiv [\Delta y_{PD1}(t) - \Delta y_{PD2}(t)] - [\Delta y_{PD1}(t - T_2) - \Delta y_{PD2}(t - T_1)] \\
 &= [H_1(t) - H_2(t) + p(t - T_1) - p(t - T_2)] \\
 &\quad - [H_1(t - T_2) - H_2(t - T_1) + p(t - T_1) - p(t - T_2)] \\
 &= H_1(t) - H_2(t) - H_1(t - T_2) + H_2(t - T_1),
 \end{aligned}$$

- Michelson interferometry

$$\begin{aligned}
 X(t) &\equiv [\Delta y_{PD2}(t - T_1) + \Delta y_{PD1}(t)] \\
 &\quad - [\Delta y_{PD1}(t - T_2) + \Delta y_{PD2}(t)]
 \end{aligned}$$

- TDI-virtual equal-arm interference

Tinto & Dhurandhar

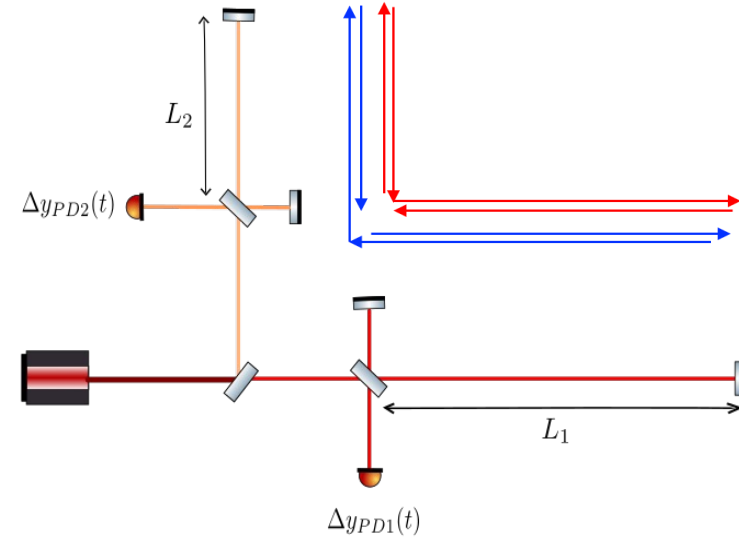

$$\begin{aligned}
 \Delta y_{PD1}(t) &= H_1(t) + p(t - T_1) - p(t), \\
 \Delta y_{PD2}(t) &= H_2(t) + p(t - T_2) - p(t),
 \end{aligned}$$

$$T_1 = 2L_1 \quad T_2 = 2L_2$$

Time-Delay Interferometry

Otto 2015

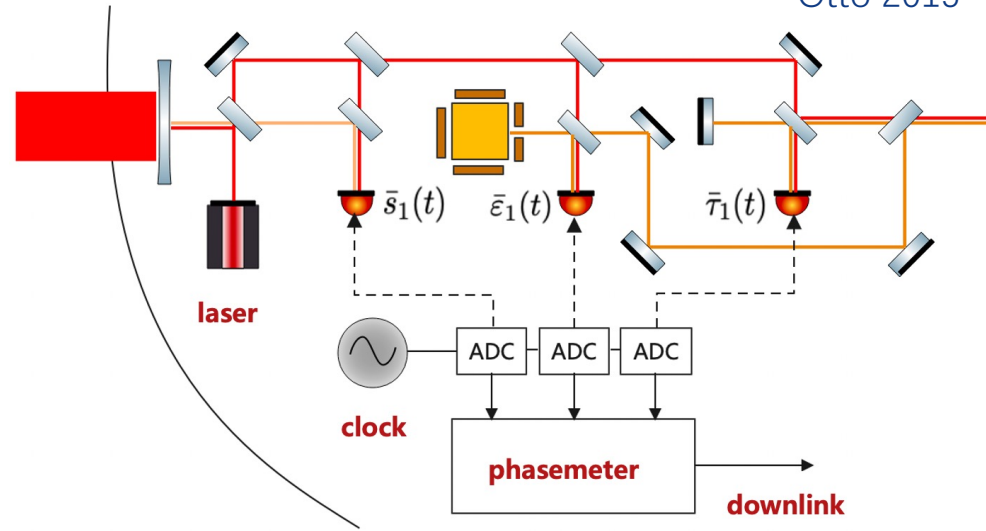
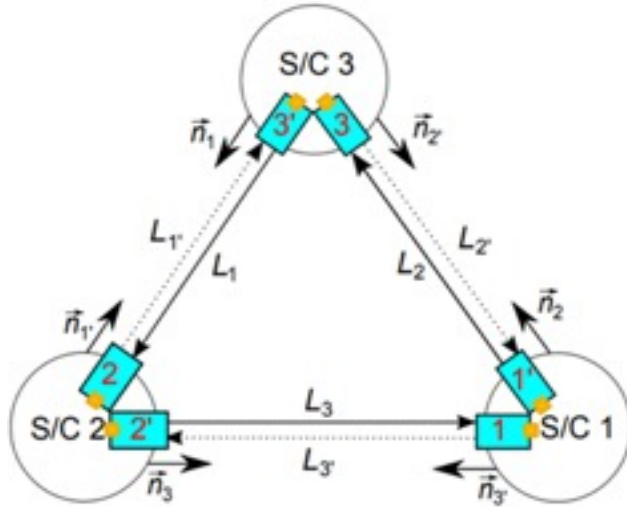

➤ Input for TDI

$$\eta_{i'} \equiv s_{i'} + \frac{\varepsilon_{i'} - \tau_{i'}}{2} + D_{i+1'} \frac{\varepsilon_{i-1} - \tau_{i-1}}{2} + \frac{\tau_i - \tau_{i'}}{2}$$

$$\eta_i \equiv s_i + \frac{\varepsilon_i - \tau_i}{2} + D_{i-1} \frac{\varepsilon_{i+1'} - \tau_{i+1'}}{2} - D_{i-1} \frac{\tau_{i+1} - \tau_{i+1'}}{2}$$

$$\eta_{1'} \sim D_{2'} p_3 - p_1, \eta_1 \sim D_3 p_2 - p_1,$$

$$\eta_{2'} \sim D_{3'} p_1 - p_2, \eta_2 \sim D_1 p_3 - p_2,$$

$$\eta_{3'} \sim D_{1'} p_2 - p_3, \eta_3 \sim D_2 p_1 - p_3.$$

➤ TDI cancels laser frequency noise

Time-Delay Interferometry

- There are multiple combinations
- Michelson channels

$$X(t) = (\eta_{2':322'} + \eta_{1:22'} + \eta_{3:2'} + \eta_{1'}) - (\eta_{3:2'3'3} + \eta_{1':3'3} + \eta_{2':3} + \eta_1),$$

$$Y(t) = (\eta_{3':133'} + \eta_{2:33'} + \eta_{1:3'} + \eta_{2'}) - (\eta_{1:3'1'1} + \eta_{2':1'1} + \eta_{3':1} + \eta_2),$$

$$Z(t) = (\eta_{1':211'} + \eta_{3:11'} + \eta_{2:1'} + \eta_{3'}) - (\eta_{2:1'2'2} + \eta_{3':2'2} + \eta_{1':2} + \eta_3).$$

- Sagnac channels

$$\alpha(t) = (\eta_{2':1'2'} + \eta_{3':2'} + \eta_{1'}) - (\eta_{3:13} + \eta_{2:3} + \eta_1),$$

$$\beta(t) = (\eta_{3':2'3'} + \eta_{1':3'} + \eta_{2'}) - (\eta_{1:21} + \eta_{3:1} + \eta_2),$$

$$\gamma(t) = (\eta_{1':3'1'} + \eta_{2':1'} + \eta_{3'}) - (\eta_{2:32} + \eta_{1:2} + \eta_3).$$

- ζ channel

$$\zeta(t) = (\eta_{1':1'} + \eta_{2':2'} + \eta_{3':3'}) - (\eta_{1:1} + \eta_{2:2} + \eta_{3:3}).$$

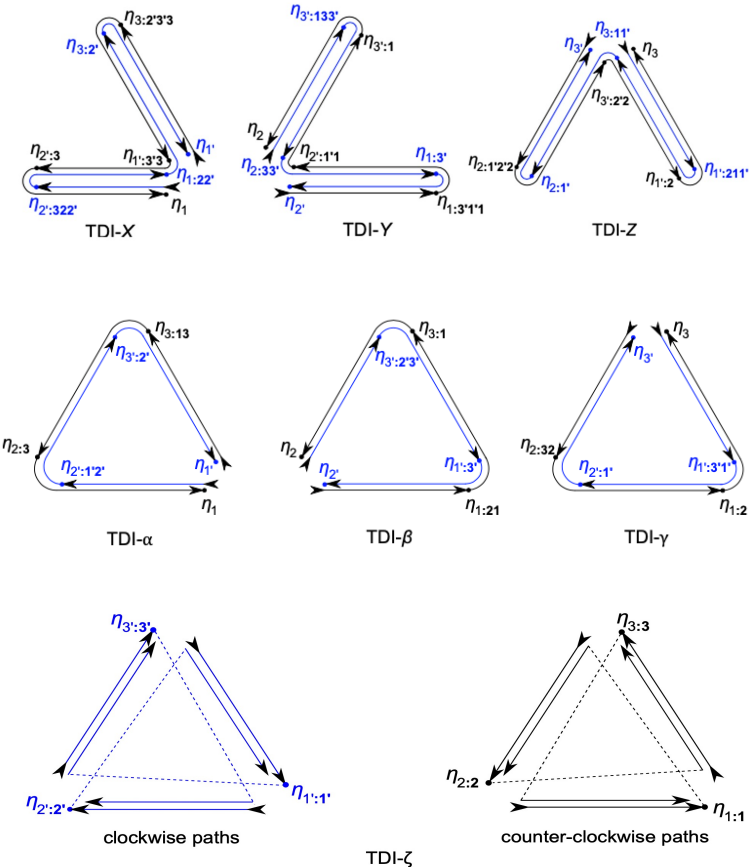

Transfer Functions

➤ Fourier transform

$$h(t) = \frac{\sqrt{T}}{2\pi} \int_0^\infty \tilde{h}(\omega) e^{i\omega t} d\omega$$

➤ One-way single link

$$y_{rs}(t) = \mu_{rs} \frac{\sqrt{T}}{2\pi} \int_0^\infty d\omega \tilde{h}(\omega) e^{i\omega t} \left[e^{-i\vec{k}\cdot\vec{x}_r} - e^{-i(\tau+\vec{k}\cdot\vec{x}_s)} \right],$$

$$\tilde{y}_{rs}(\omega) = \mu_{rs} \tilde{h}(\omega) \left[e^{-i(\vec{k}\cdot\vec{x}_r)} - e^{-i(\tau+\vec{k}\cdot\vec{x}_s)} \right].$$

➤ Transfer function, sky and polarization averaged

$$R(\omega) = \left| \frac{\tilde{y}_{rs}(\omega)}{\tilde{h}(\omega)} \right|^2,$$

$$I_s \equiv \frac{1}{4\pi} \int_{-1}^1 d\cos\theta_1 \int_0^{2\pi} d\epsilon_1 \dots,$$

$$I_v \equiv \frac{1}{16\pi^2} \int_{-1}^1 d\cos\theta_1 \int_0^{2\pi} d\epsilon_1 \int_{-1}^1 d\cos\theta_2 \int_0^{2\pi} d\epsilon_2 \dots$$

$$I_{GW} \equiv \frac{1}{8\pi^2} \int_{-1}^1 d\cos\theta_1 \int_0^{2\pi} d\epsilon_1 \int_0^{2\pi} d\psi \dots$$

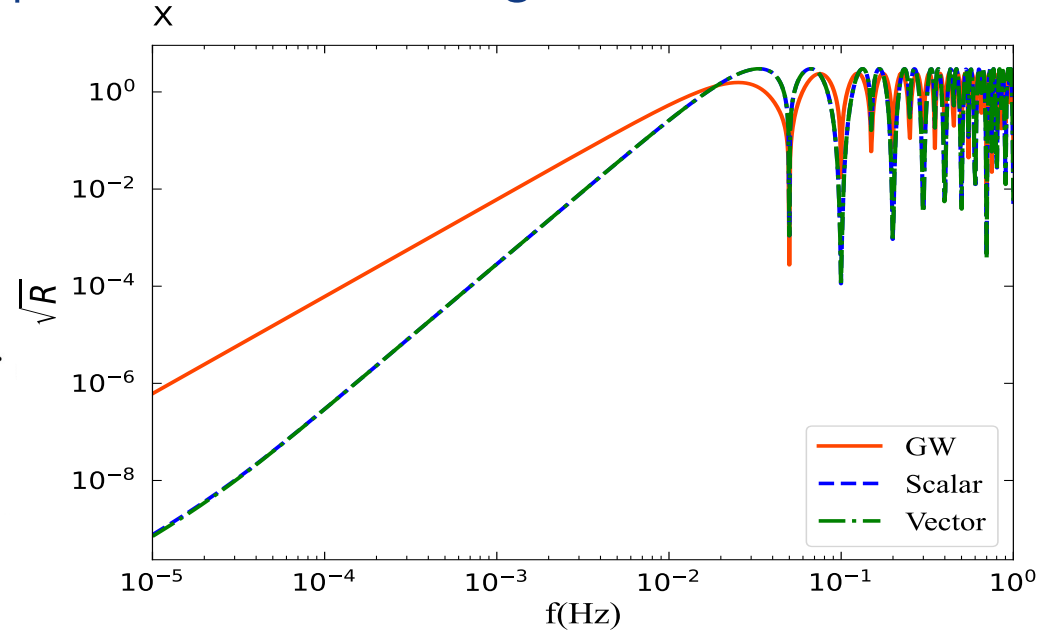

Transfer Functions

- Different channels have different transfer functions
- DM is also different from gravitational wave, velocity effect, ...

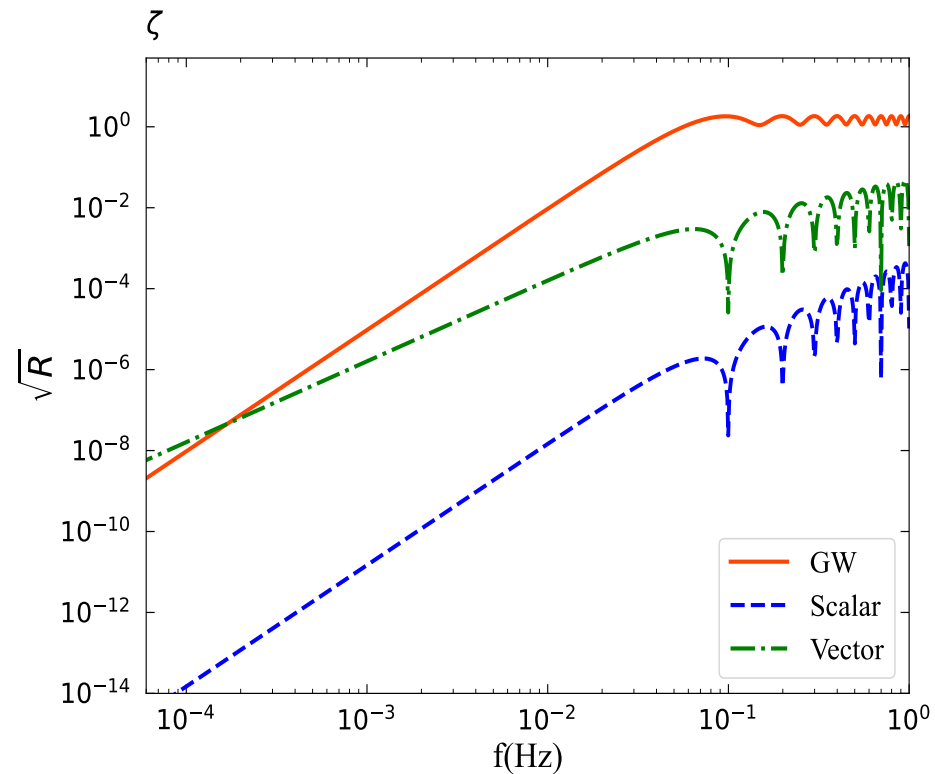
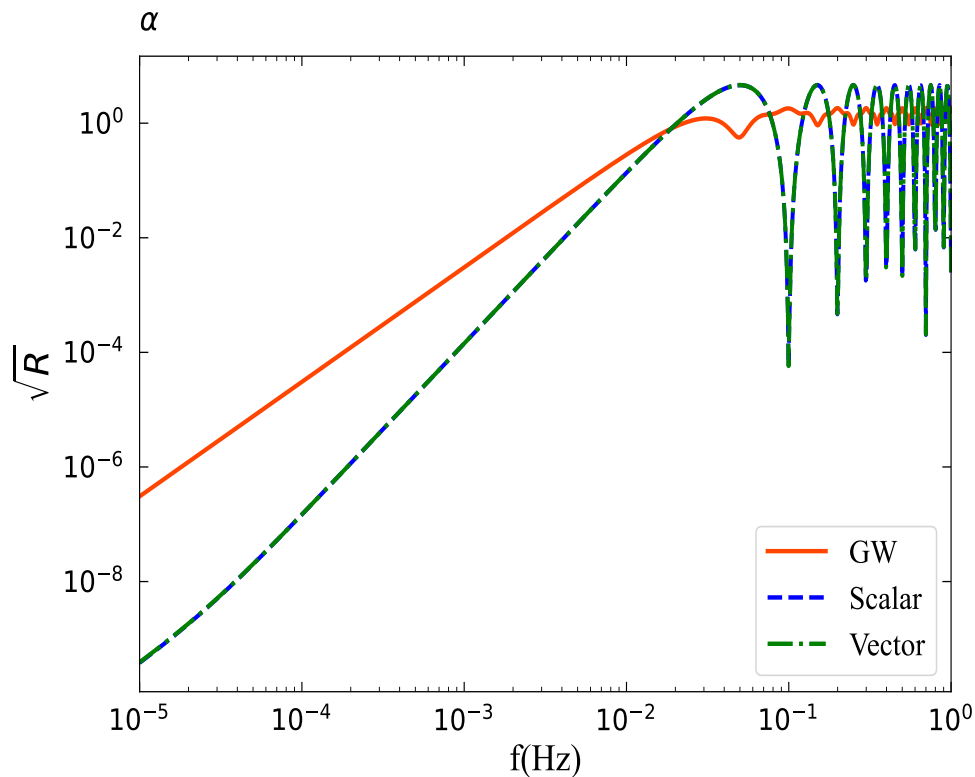

Sensitivity

➤ Defined by $S_O(f) = \frac{N_O(f)}{R_O(f)}$, $N_X = 16 \sin^2(\tau) \{ [3 + \cos(2\tau)] S_{acc} + S_{oms} \}$, $\tau = 2\pi f L$

$$S_{oms}(f) = \left(s_{oms} \frac{2\pi f}{c} \right)^2 \left[1 + \left(\frac{2 \times 10^{-3} \text{ Hz}}{f} \right)^4 \right] \frac{1}{\text{Hz}},$$

$$S_{acc}(f) = \left(\frac{s_{acc}}{2\pi f c} \right)^2 \left[1 + \left(\frac{0.4 \times 10^{-3} \text{ Hz}}{f} \right)^2 \right] \left[1 + \left(\frac{f}{8 \times 10^{-3} \text{ Hz}} \right)^4 \right] \frac{1}{\text{Hz}},$$

LISA : $s_{oms} = 15 \times 10^{-12} \text{ m}$, $s_{acc} = 3 \times 10^{-15} \text{ m/s}^2$,

Taiji : $s_{oms} = 8 \times 10^{-12} \text{ m}$, $s_{acc} = 3 \times 10^{-15} \text{ m/s}^2$,

TianQin : $s_{oms} = 1 \times 10^{-12} \text{ m}$, $s_{acc} = 1 \times 10^{-15} \text{ m/s}^2$.

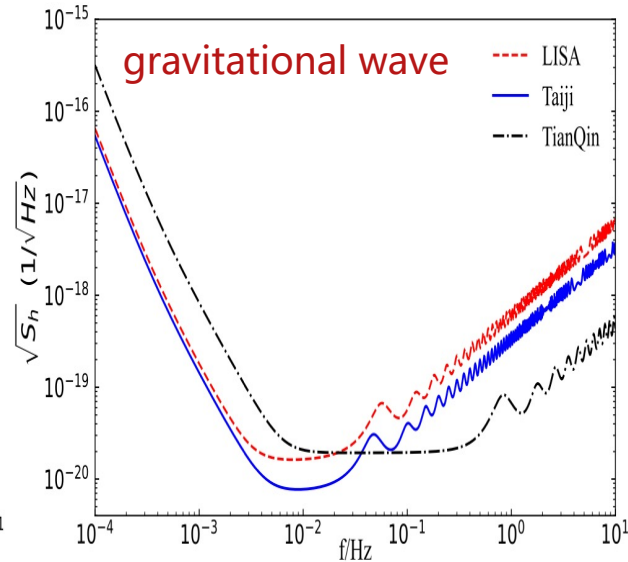
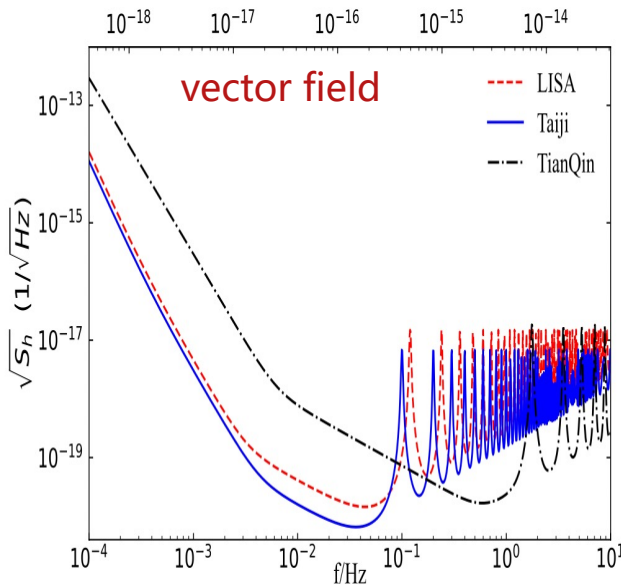
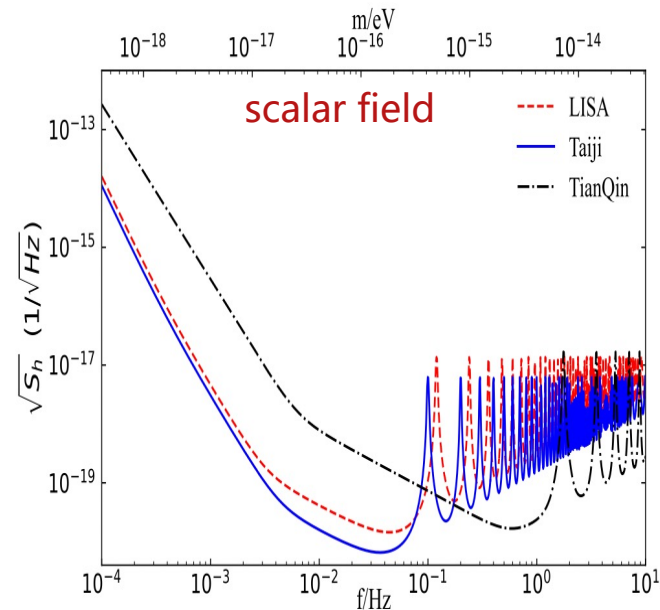

Sensitivity

Prince, Tinto, Larson & Armstrong

➤ Optimal channels $A = \frac{1}{\sqrt{2}} [Z - X], E = \frac{1}{\sqrt{6}} [X - 2Y + Z], T = \frac{1}{\sqrt{3}} [X + Y + Z]. \frac{1}{S_\eta} = \frac{1}{S_A} + \frac{1}{S_E} + \frac{1}{S_T}$

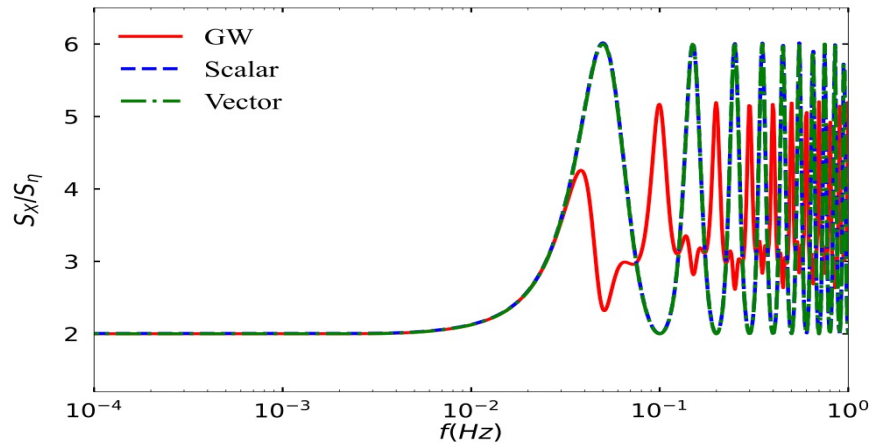
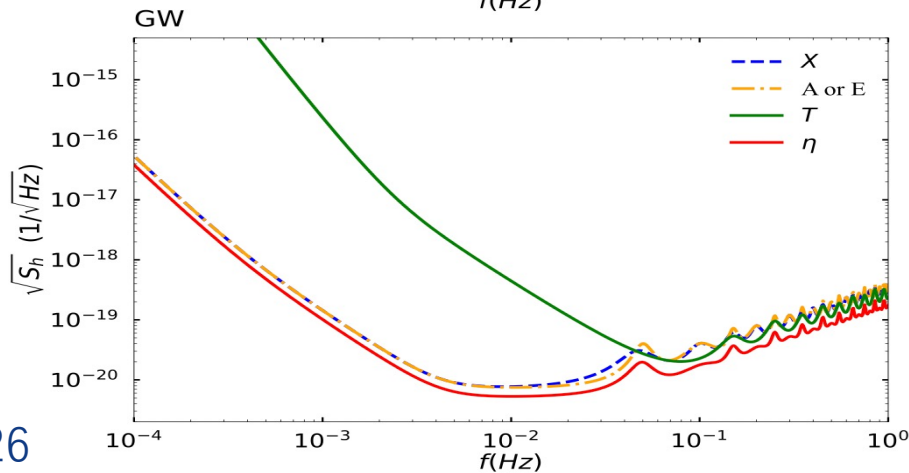
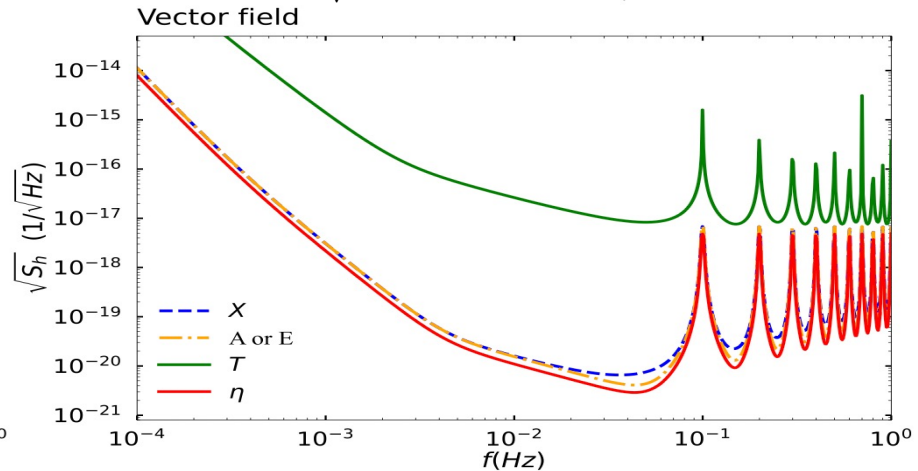
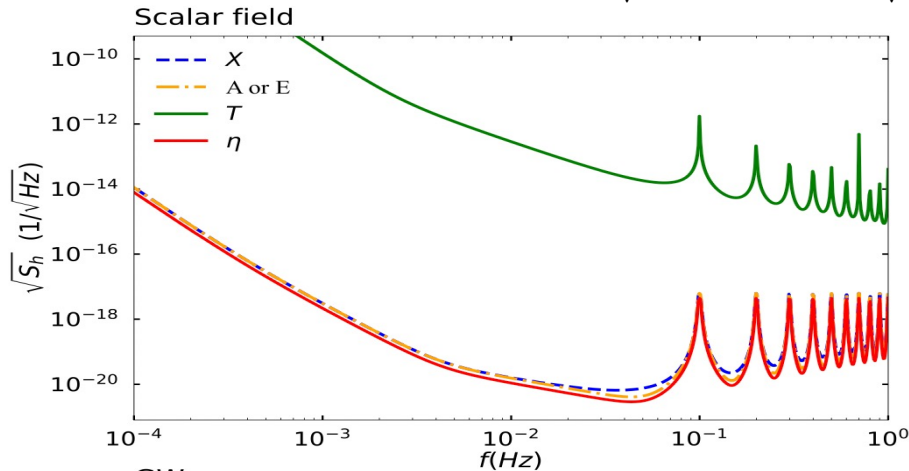

Sensitivity on scalar DM

➤ Strong sector $\delta\mathcal{L} = \frac{\phi}{M_P} \left[-\frac{d_g\beta_3}{2g_3} F_{\mu\nu}^A F^{A\mu\nu} - \sum_{i=u,d} (d_{m_i} + \gamma_{m_i}d_g) m_i \bar{\psi}_i \psi_i \right]$ Damour & Donoghue

$$d_{\hat{m}} \equiv \frac{d_{m_d}m_d + d_{m_u}m_u}{m_d + m_u},$$

$$d_g^* \approx d_g + 0.093(d_{\hat{m}} - d_g).$$

assuming $d_m = 0$ and $d_g^* \approx 0.9d_g$.

➤ Equivalence principle is violated.

➤ MICROSCOPE

➤ Other Shao, Wex, Kramer, arXiv:1805.08408(PRL)

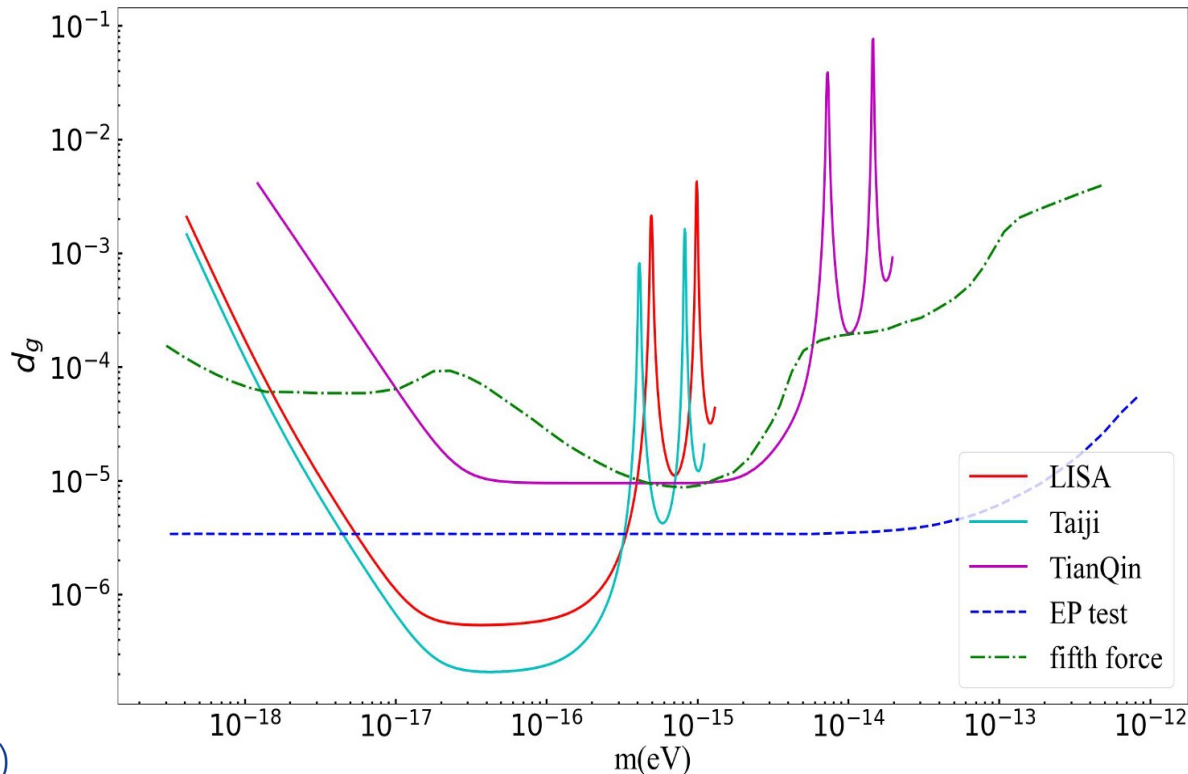

Yu, Yao, Tang, Wu, arXiv: 2307.09197

Sensitivity on vector DM

- For example, vector fields couple to baryon number B , or $B-L$, effectively neutron number. Sensitivity on ratio $\epsilon_D = e_D/e$

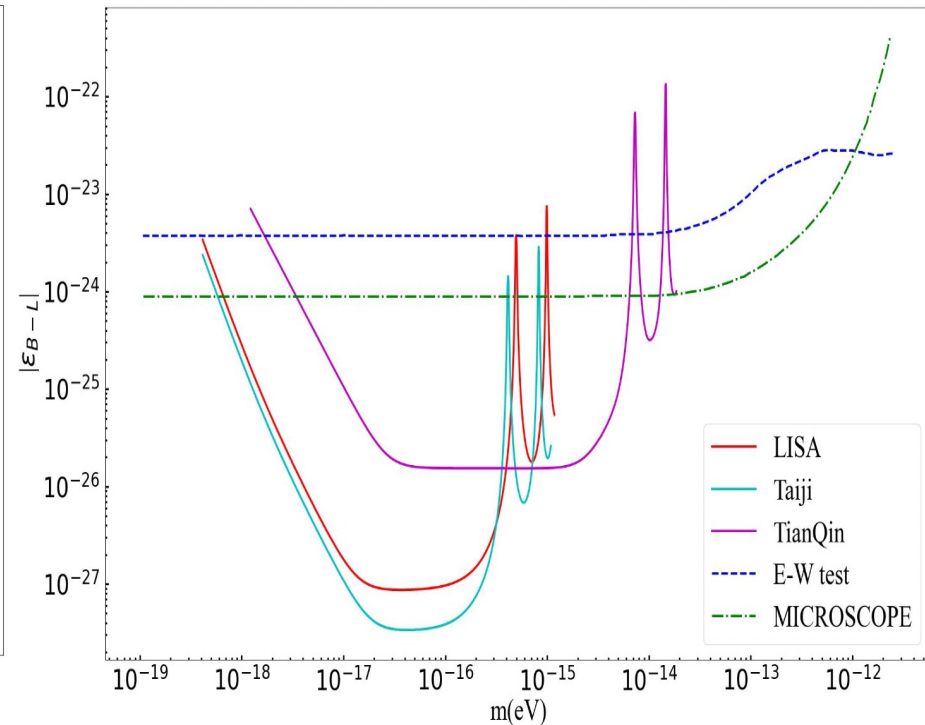
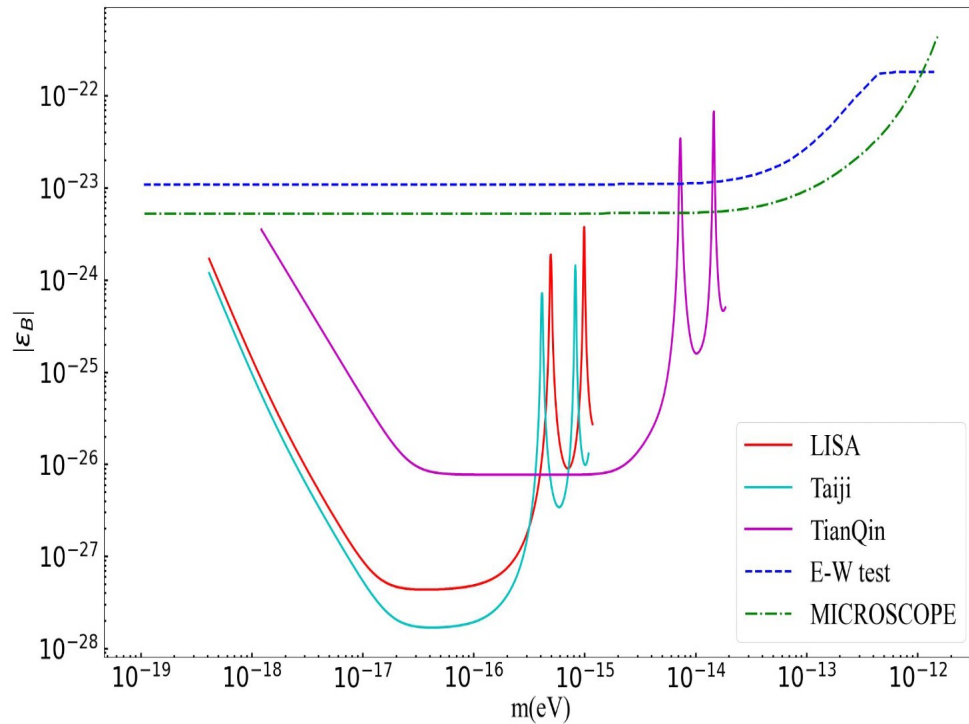

Statistical Effects

➤ Velocity distributions, likelihood analysis

$$S_O(\lambda_{\min}) = \left(\frac{\ln \alpha}{\ln \gamma} - 1 \right) N_O, \quad \lambda_{\min}^2 = \frac{N_O}{\Gamma_O S_{\Phi}} \left(\frac{\ln \alpha}{\ln \gamma} - 1 \right).$$

$$\gamma = \int_{P_*(\alpha)}^{\infty} dP \mathcal{L}_{\text{stoch}}(\tilde{d} | S_O(\lambda_{\min}), N_O), \quad \text{detection probability}$$

$$\alpha = \int_{P_*}^{\infty} dP \mathcal{L}_{\text{stoch}}(P | \lambda = 0, N_O). \quad \text{false alarm rate}$$

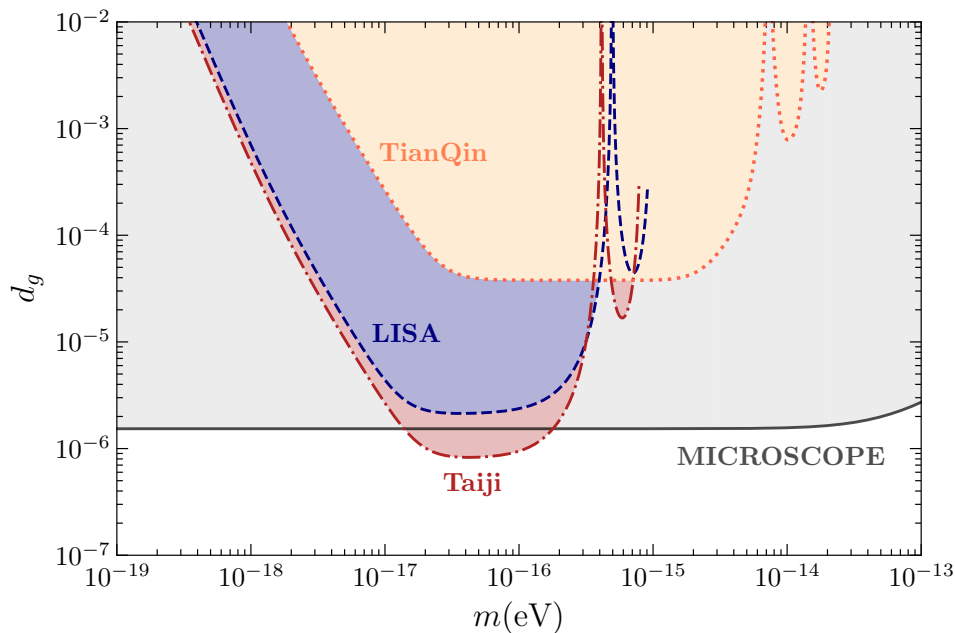
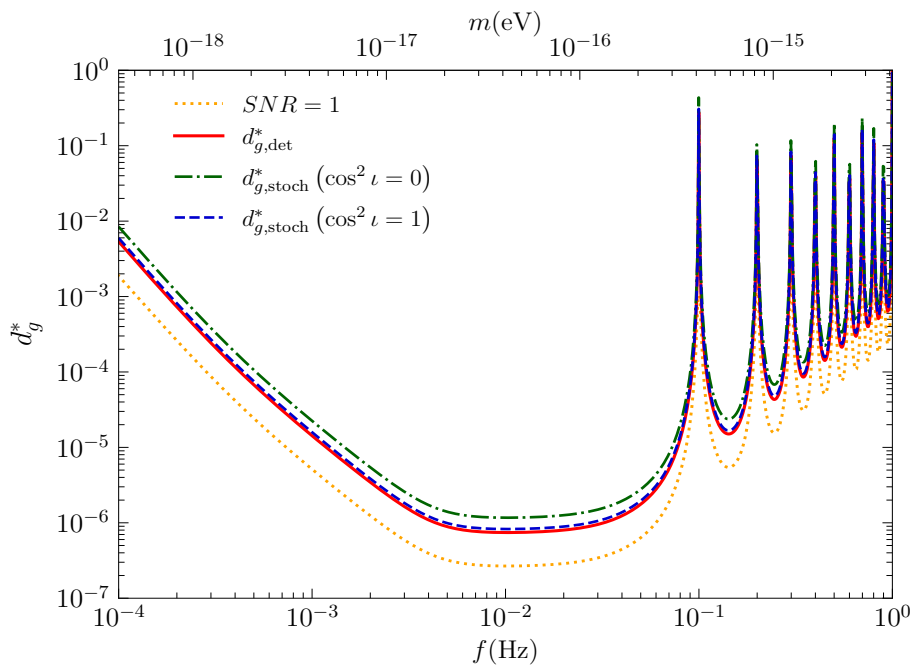

Correlation

- Network of detectors

$$\gamma_{ab}(f, \nu) := \int d\hat{k} \chi_{ab}(f, \hat{k}, \nu), \quad \lambda_{\min}^2 = \frac{N}{2\Gamma_X S_\Phi} \left(\frac{\ln \alpha}{\ln \gamma} - 1 \right).$$

- Correlation length is larger
- Sensitivity is enhanced by \sqrt{n}
- Different from SGWB searches which has \sqrt{T} enhancement.
- How to distinguish them.
- Anisotropy and TDI

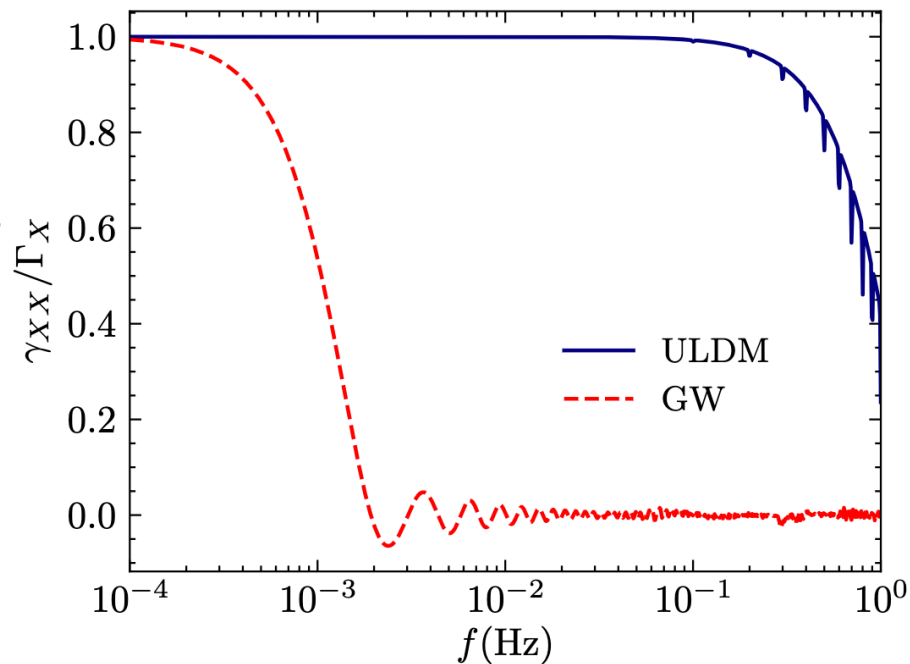

Detecting Ultralight Dark Matter Gravitationally

- Metric perturbation in solar system

$$ds^2 = -(1 + 2\Psi)dt^2 + (1 - 2\Phi)\delta_{ij}dx^i dx^j + h_{ij}dx^i dx^j$$

- Einstein equations

$$\partial_i \partial^i \Phi = 4\pi G T_{00},$$

$$3\ddot{\Phi} + \partial_i \partial^i (\Psi - \Phi) = 4\pi G T_k^k,$$

$$\ddot{h}_{ij} = 16\pi G \left(T_{ij} - \frac{1}{3} \delta_{ij} T_k^k \right),$$

$$\Psi^j \simeq \Phi^j \simeq \pi G \frac{\rho}{m^2} = \frac{7 \times 10^{-26} \rho}{0.4 \text{ GeV/cm}^3} \left(\frac{10^{-18} \text{ eV}}{m} \right)^2,$$

$$h_{ij}^v \propto h_0 \simeq \frac{8}{3} \pi G \frac{\rho}{m^2} = \frac{2 \times 10^{-25} \rho}{0.4 \text{ GeV/cm}^3} \left(\frac{10^{-18} \text{ eV}}{m} \right)^2,$$

$$h_{ij}^s \simeq h_0 v^2 / 2$$

- Tensor perturbation for scalar and tensor ULDM is suppressed.

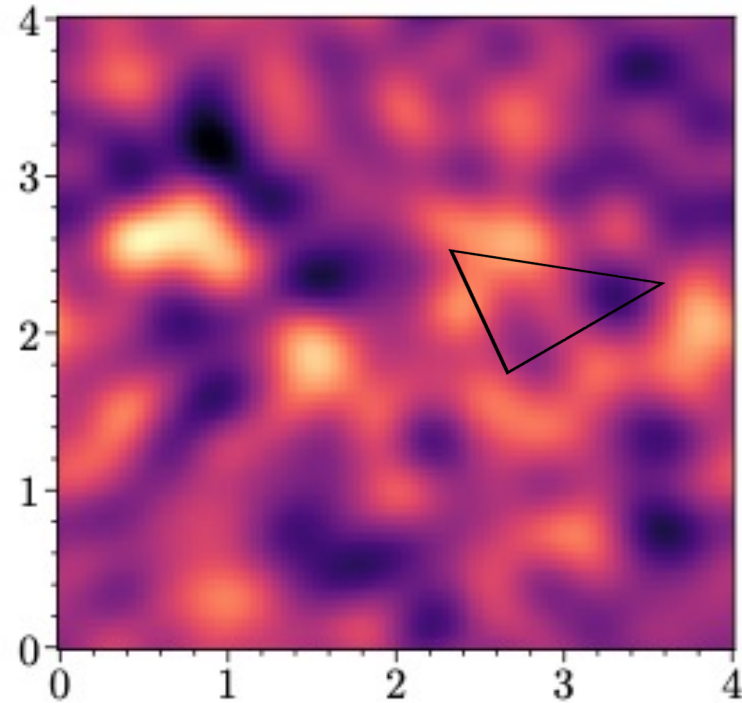

Detecting Ultralight Dark Matter Gravitationally

- Metric perturbation in solar system

$$ds^2 = -(1 + 2\Psi)dt^2 + (1 - 2\Phi)\delta_{ij}dx^i dx^j + h_{ij}dx^i dx^j$$

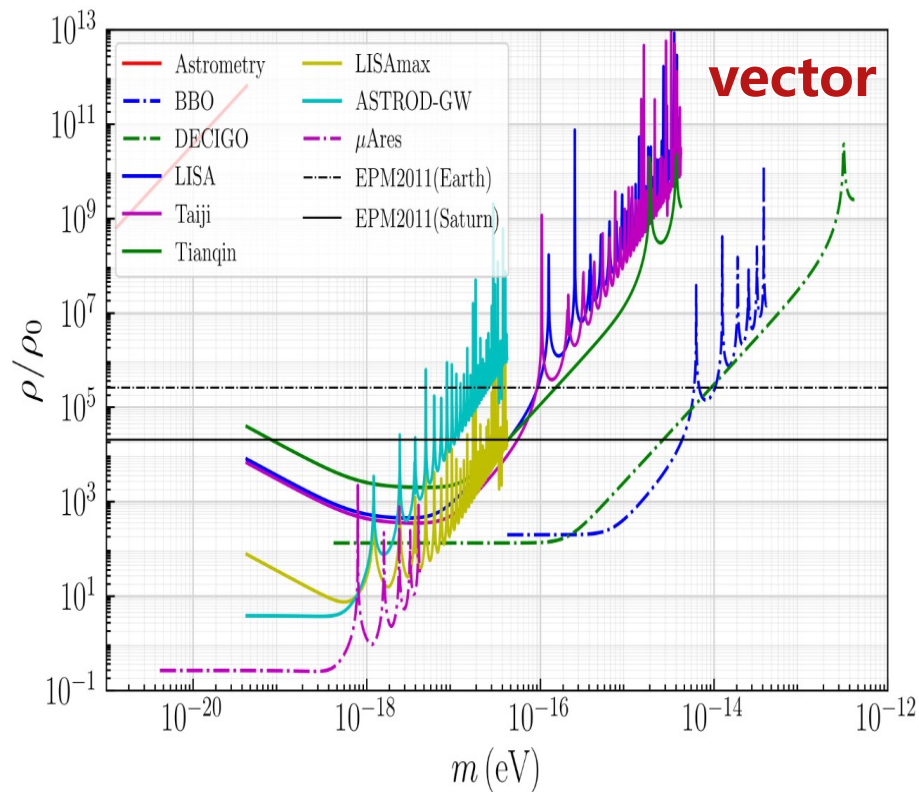
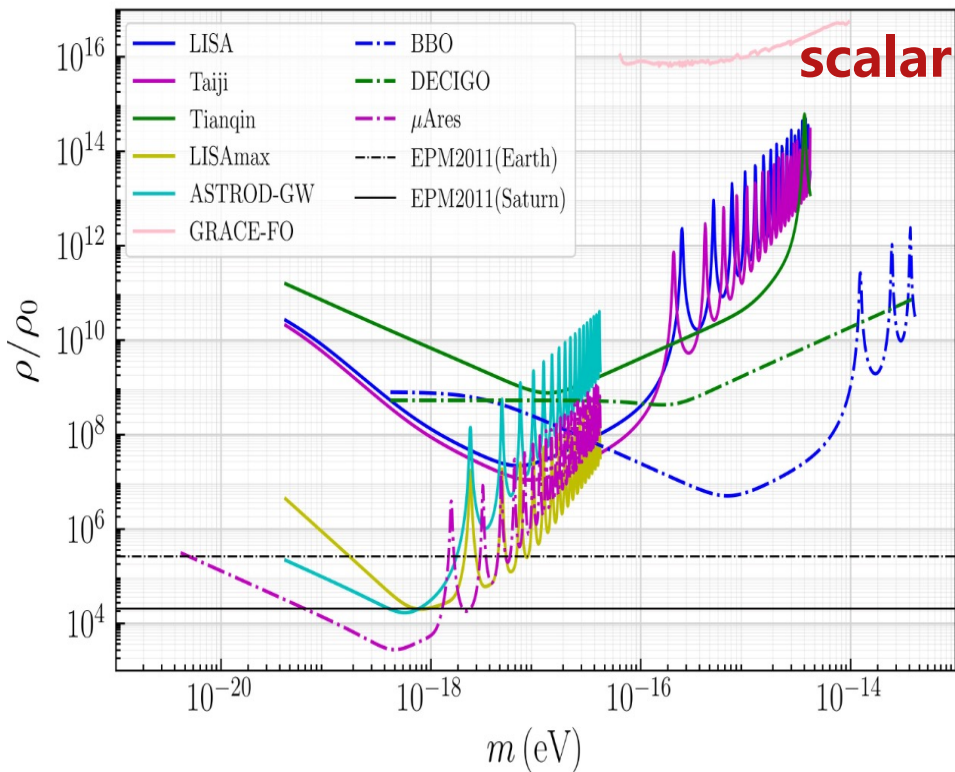

Detecting Ultralight Dark Matter Gravitationally

- Metric perturbation in solar system

$$ds^2 = -(1 + 2\Psi)dt^2 + (1 - 2\Phi)\delta_{ij}dx^i dx^j + h_{ij}dx^i dx^j$$

- Different channels have different sensitivities

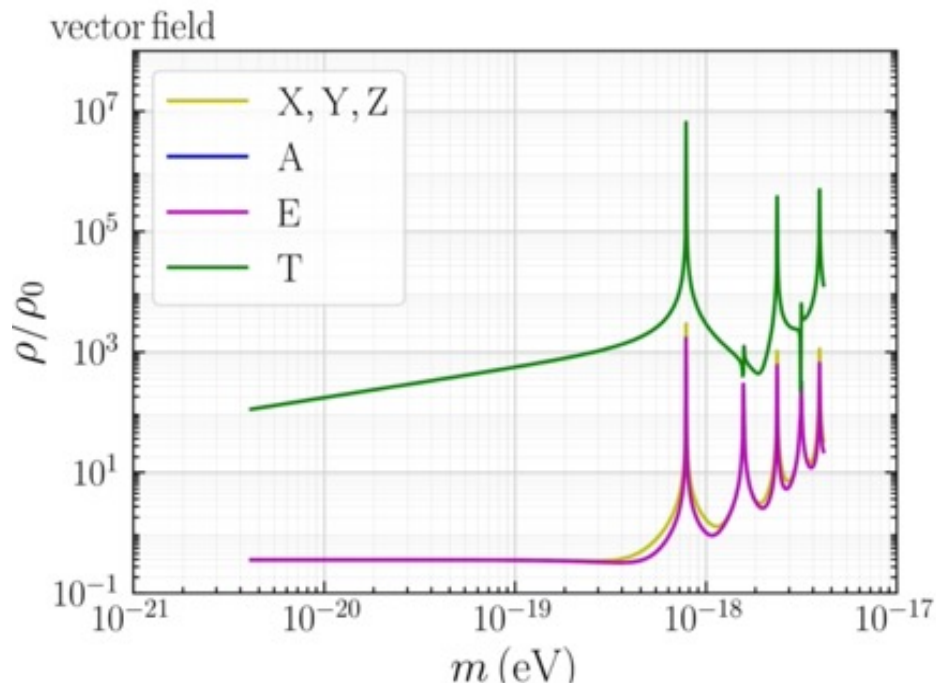
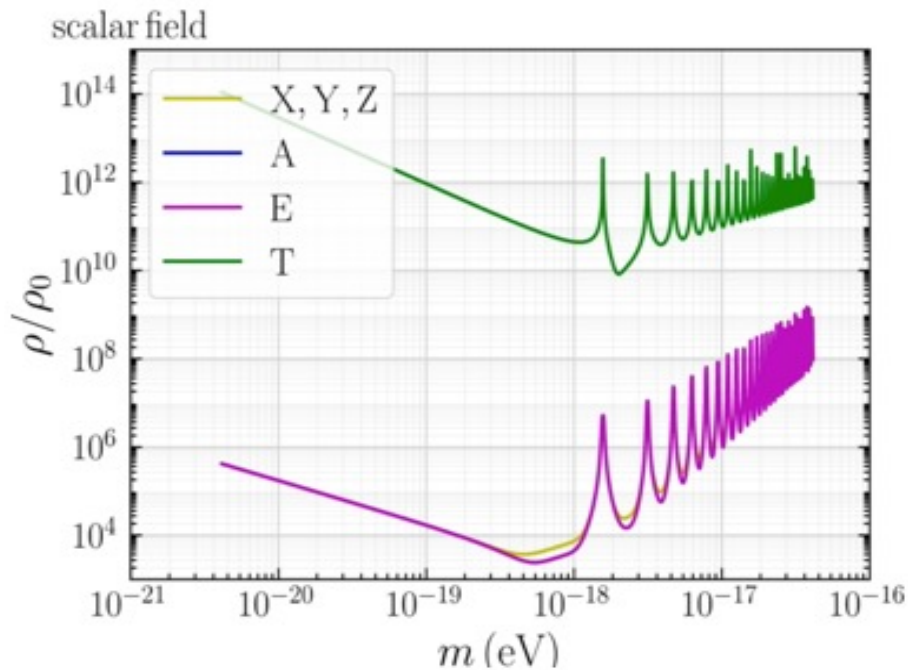

Summary

- We discuss how gravitational-wave detectors in space may help to understand the nature of dark matter.
- Weakly-interacting massive particles
 - can form spikes around black holes and affect the orbiting compact objects, imprinting on the waveform of GW.
 - Relativistic effect, velocity distribution, ...
- Ultralight bosonic, wave like
 - can couple to normal matter and induce the oscillation of test masses, leading to signals in detectors and very good sensitivities.
 - Metric perturbation by vector ULDM may be detectable in future.